



# ***WALL PANEL***

<https://harmer-coverings.ru>

Тел: +7(962)427-47-22

# 配套产品截面图 | Products Sectional View

## 120 Series · 120 双筋孔墙板

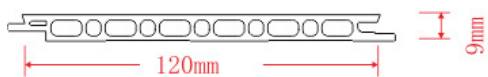

直缝 Item:120F9



V缝 Item:120V9

## Joining Finish for Wall Panel · 实物拼接效果图

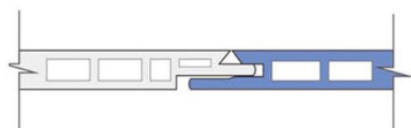

直缝 Seamless Design (F)

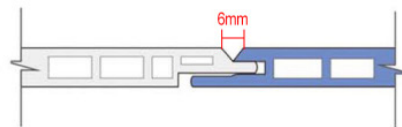

V缝 V Design (V)

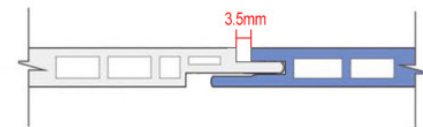

U缝 U Design (U)

## 300 Series · 300 双筋孔墙板

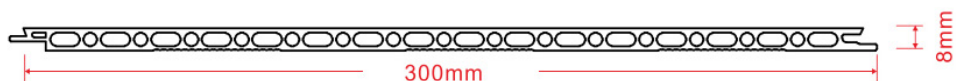

直缝 Item:300F8

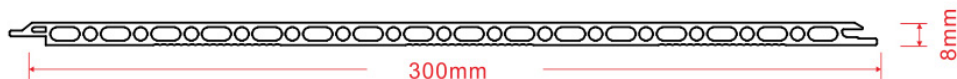

V缝 Item:300V8

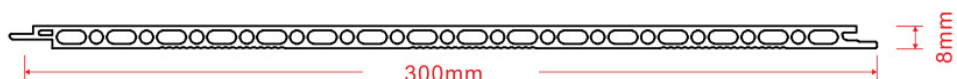

U缝 Item:300U8

# 配套产品截面图 | Products Sectional View

## 400 Series · 400 双筋孔墙板

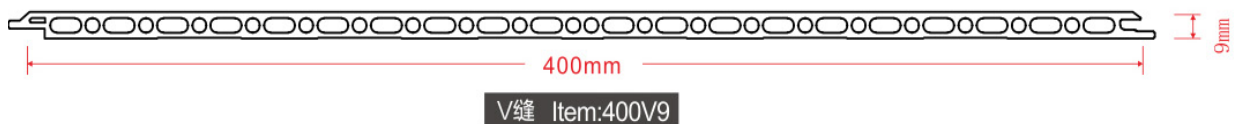
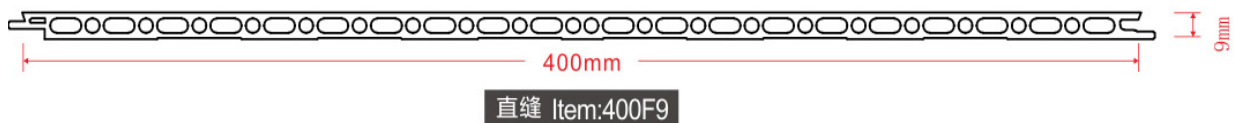
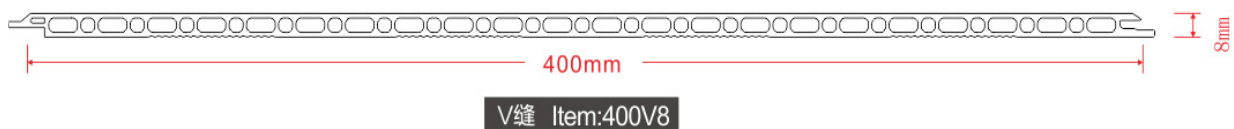
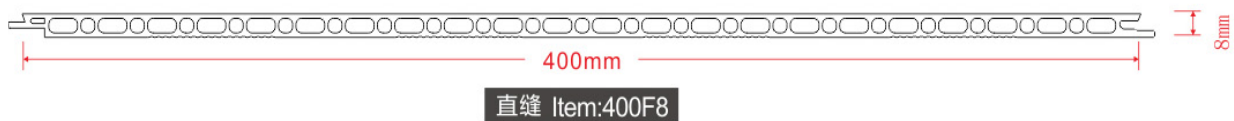

## 600 Solid Series · 600 实心墙板

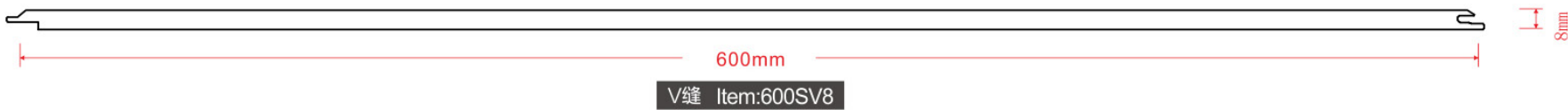

# 配套产品截面图 | Products Sectional View

600 C9 · 600 开槽板

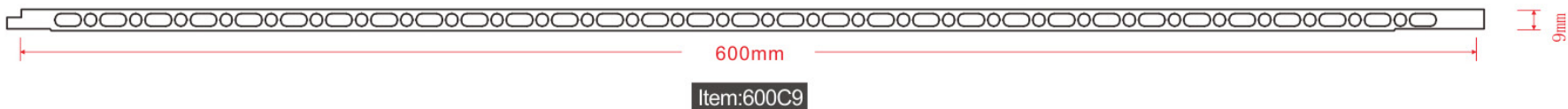

600 B Series · 600 蝴蝶孔板

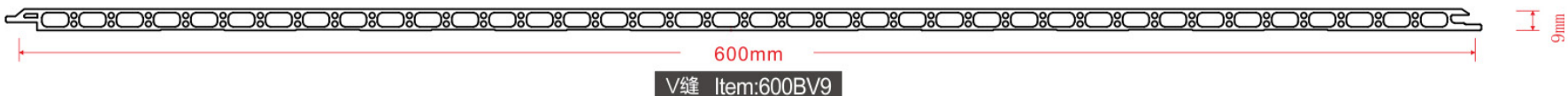
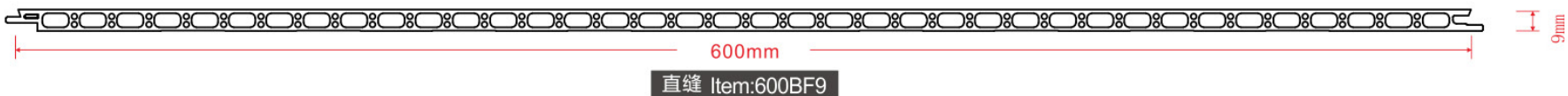

600 H Series · 600 豪装板

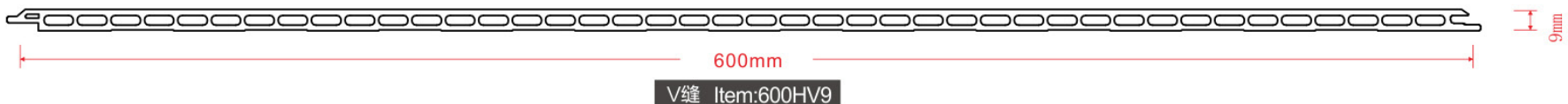
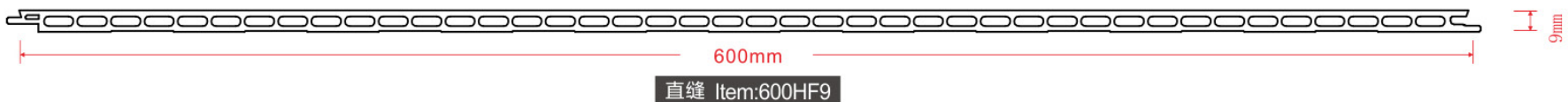

# 配套产品截面图 | Products Sectional View

## 600 Y Series · 600 益禾板

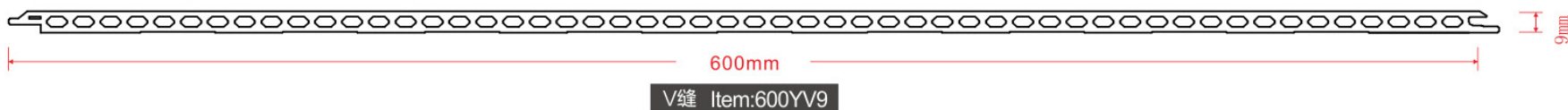
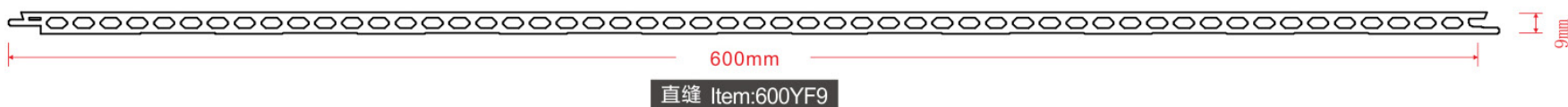

## 600 D Series · 600 双筋孔墙板

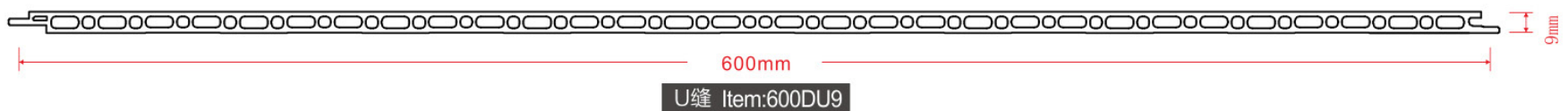
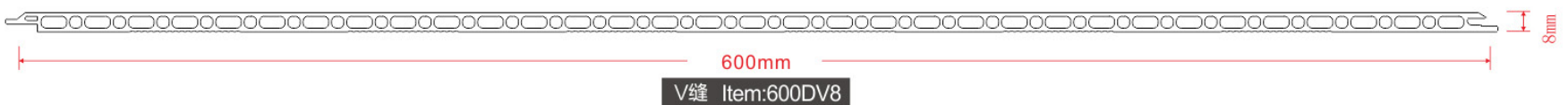
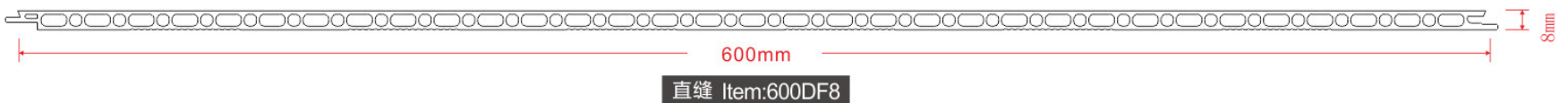

# 配套产品截面图 | Products Sectional View

## 800 X Series · 800 悦享板

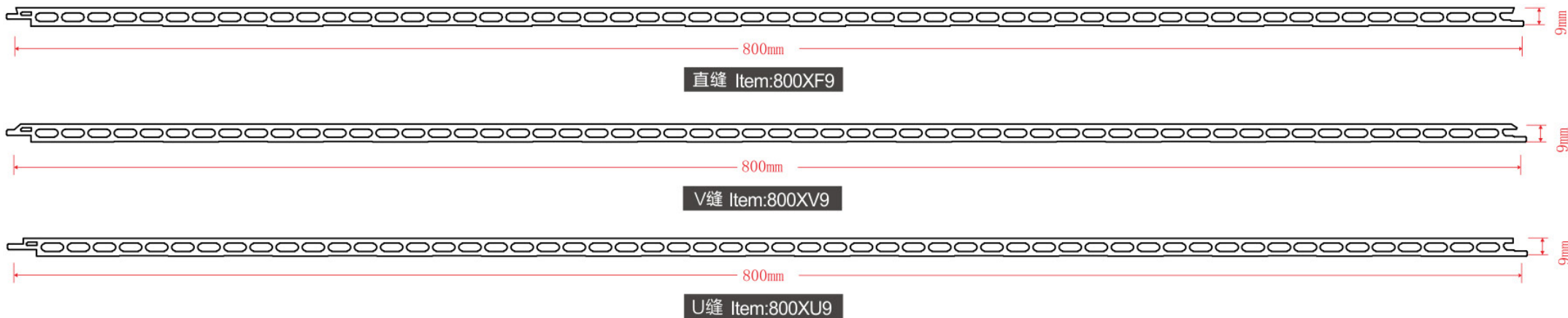

## 1200mm SREP Series · SREP 实心大板

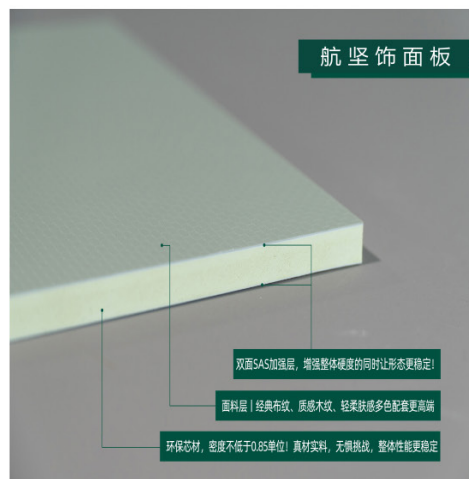

# 配套产品截面图 | Products Sectional View

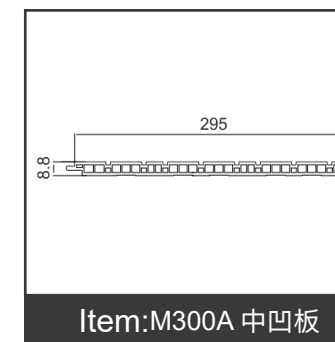
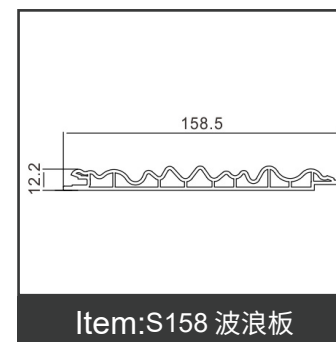
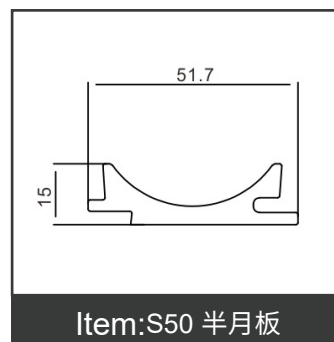
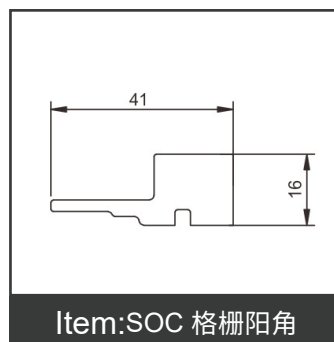
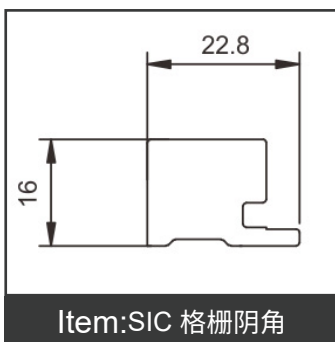
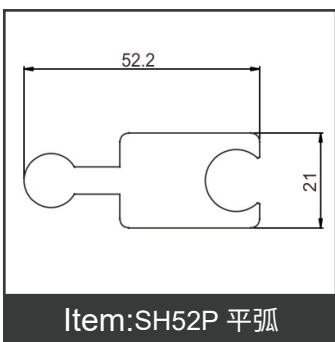
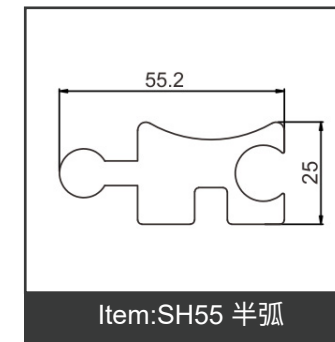
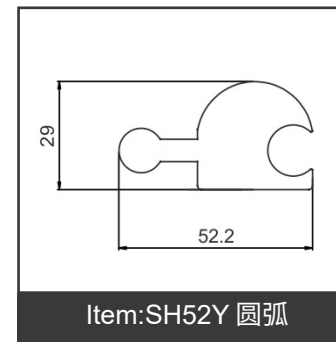
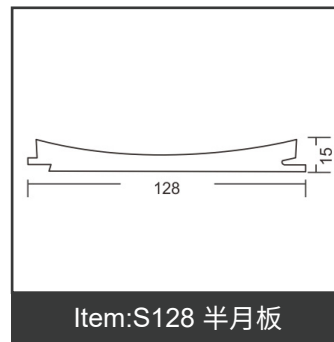
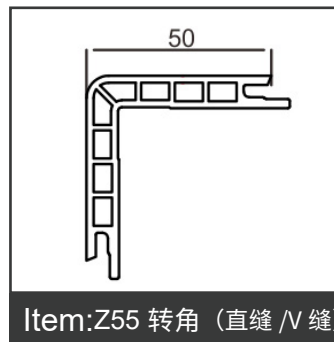
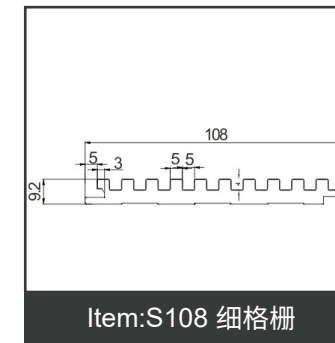
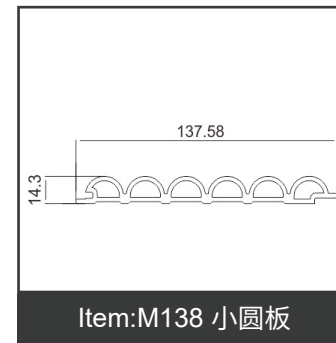
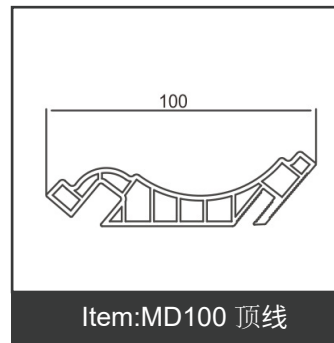
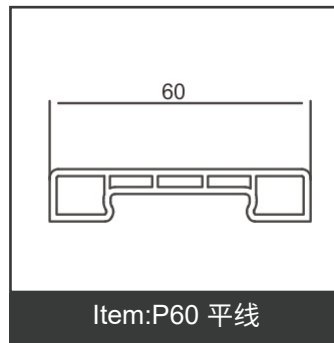
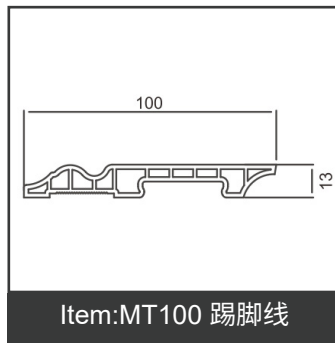

# 配套产品截面图 | Products Sectional View

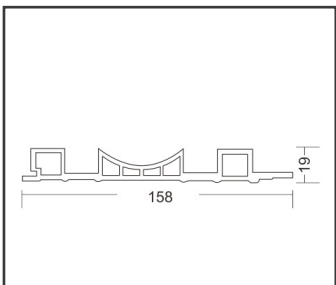

Item:M158 中凹板

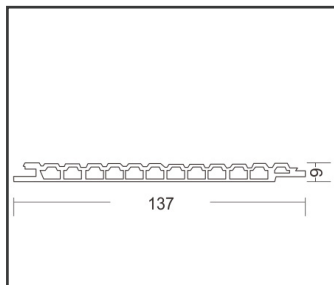

Item:M137 波格板

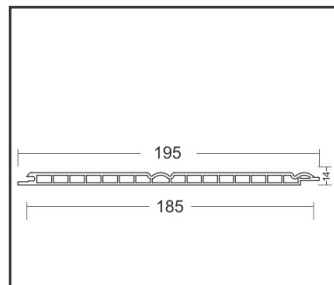

Item:M195 中板

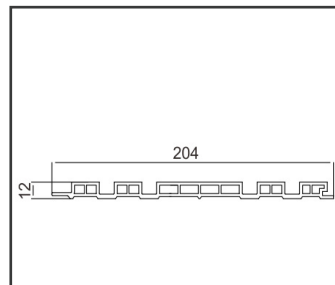

Item:M196 组合板

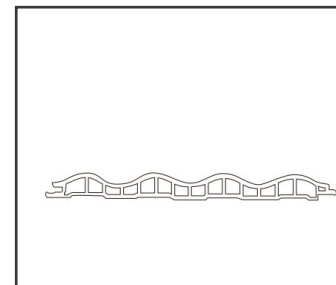

Item:M205 外圆板

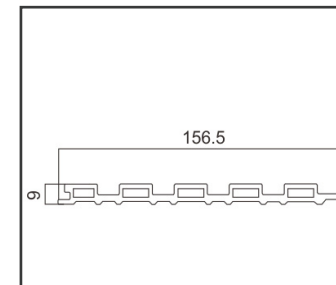

Item:M159 小长城板

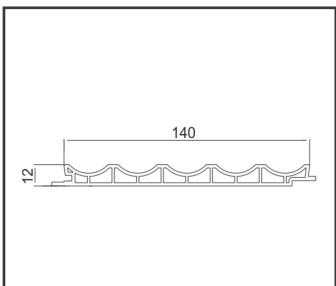

Item:M150Y 内圆板

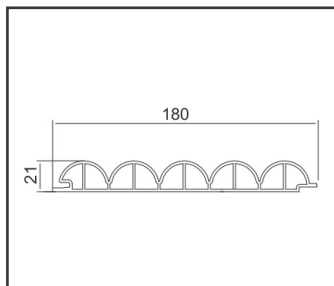

Item:M180 外弧装饰板

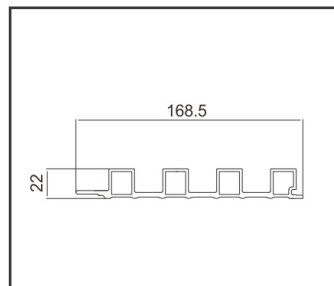

Item:M170 格栅板

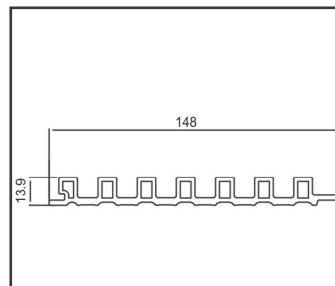

Item:M148 细格栅

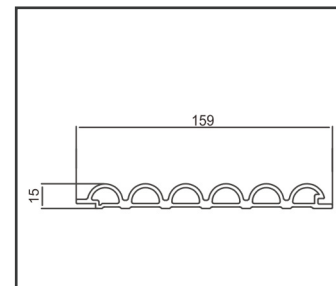

Item:M160 小圆板

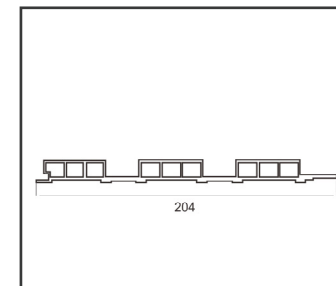

Item:M204 长城板

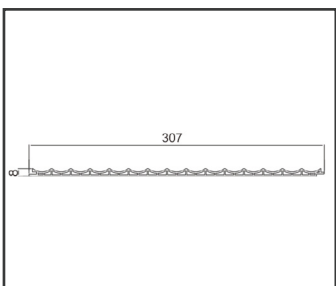

Item:M300B 波浪板

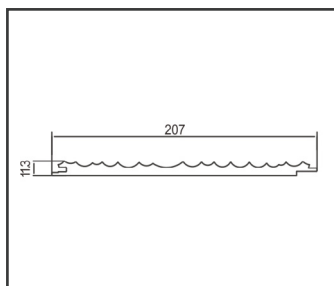

Item:S207 波浪板

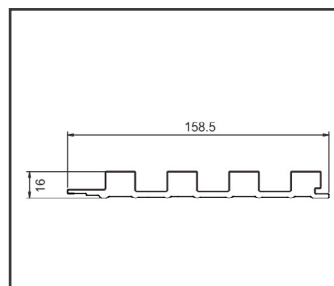

Item:S1516 实心格栅

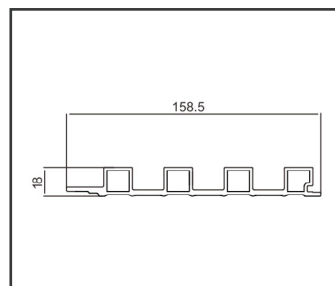

Item:M150X 小格栅

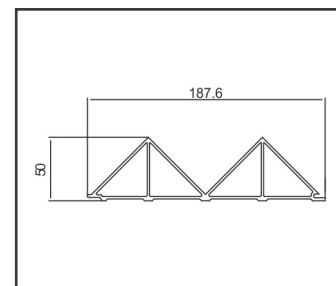

Item:MT 大三角板

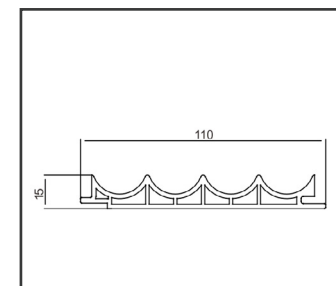

Item:MT110 内圆板



# 配套产品截面图 | Products Sectional View

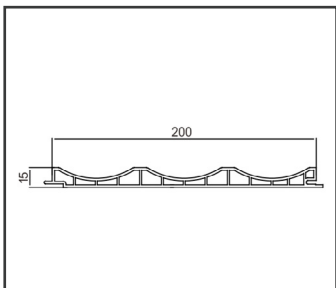

Item: M210 三圆板

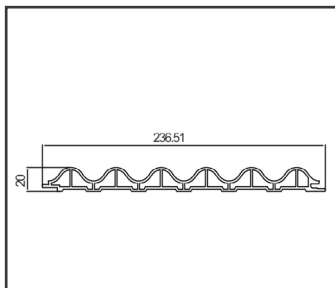

Item: M240 圆弧板

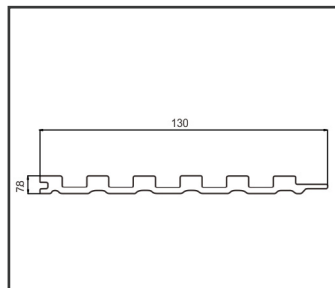

Item: S130 小长城板

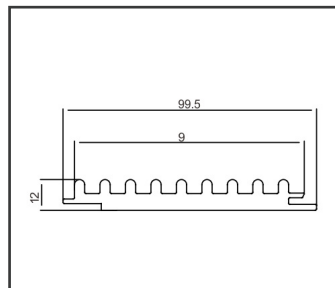

Item: SM100 波浪板

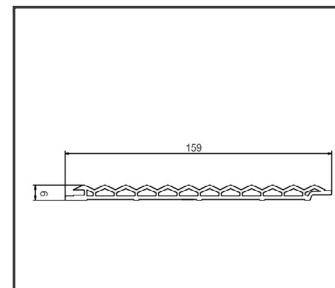

Item: M159 小三角板

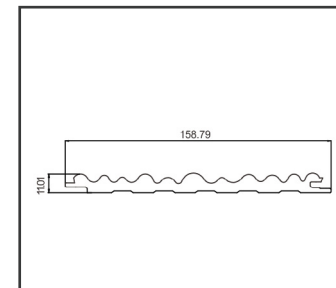

Item: S162 波浪板

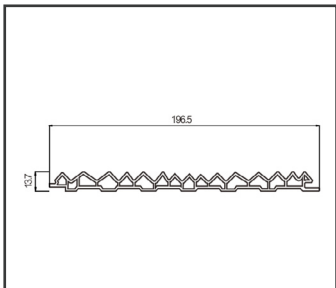

Item: M190 三角板

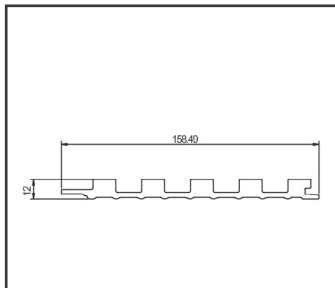

Item: S159 实心格栅

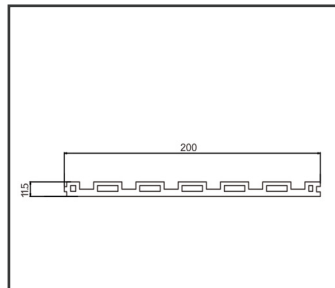

Item: S200 中凹板

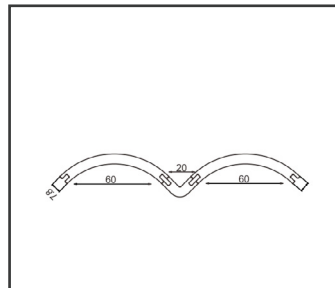

Item: LH 连接弧

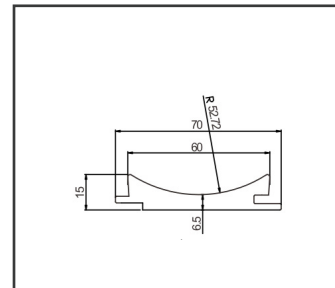

Item: S7015 半月板

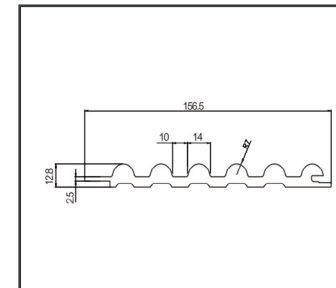

Item: S156 半圆板

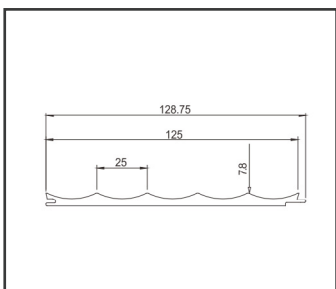

Item: S125 波浪板

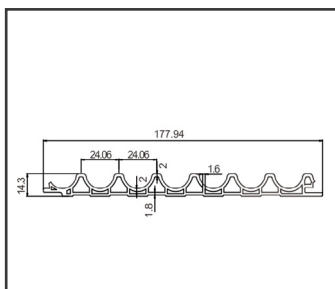

Item: M178 内圆板

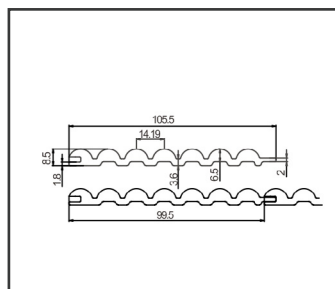

Item: S105 小圆板

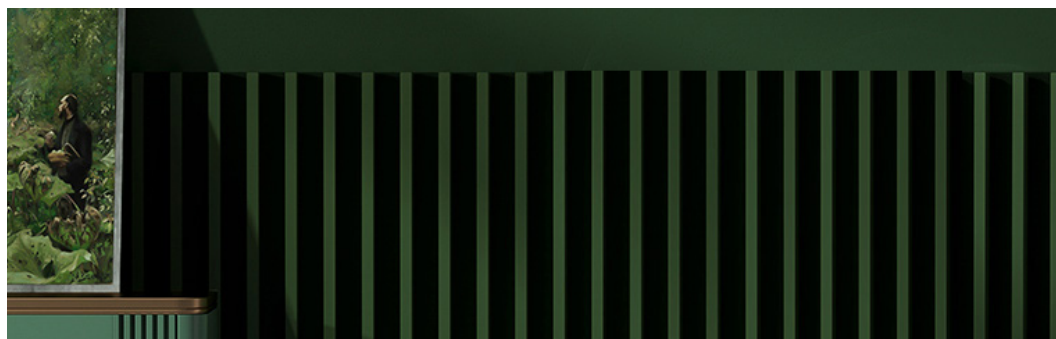



高端室内装饰板· 现货供应

High Quality Interior Wall Panel

# Item:M137 Series



·M137 - XR-02 DC-002  
·M137 - 磨砂白



·M137 - XR-06 DL-002  
·M137 - 埃尔斯灰



·M137 - QY-37 FG-003  
·M137 - 浅灰肤感



·M137 - QY-38 FG-004  
·M137 - 子午灰



·M137 - QY-40 FG-006  
·M137 - 冰极绿



·M137 - QY-44 FG-010  
·M137 - 薄荷绿



·M137 - XR-20 BY-011  
·M137 - 莫兰迪 2



·M137 - XR-28 BY-019  
·M137 - 黑拉丝



·M137 - XR-57 MX-023  
·M137 - 科技柚木



·M137 - XR-58 MX-024  
·M137 - 科技木灰



·M137 - XR-59 MX-025  
·M137 - 金丝檀木

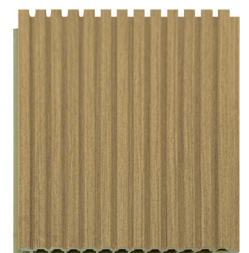

·M137 - XR-60 MX-026  
·M137 - 米兰橡木



·M137 - XR-61 MX-027  
·M137 - 花火菲丝



·M137 - XR-63 MX-029  
·M137 - 酸枝木

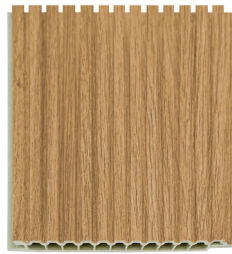

·M137 - XR-64 MX-030  
·M137 - 托尼木



·M137 - XR-65 MX-031  
·M137 - 北美樱桃

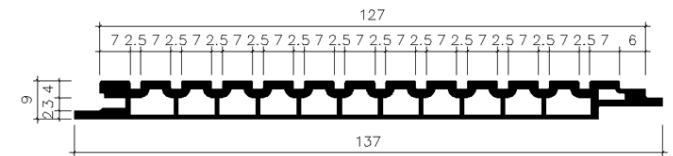

M137 波格板

# Item:M148 Series



·M148 - XR-02 DC-002  
·M148 - 磨砂白



·M148 - XR-06 DL-002  
·M148 - 埃尔斯灰



·M148 - QY-37 FG-003  
·M148 - 浅灰肤感



·M148 - QY-38 FG-004  
·M148 - 子午灰

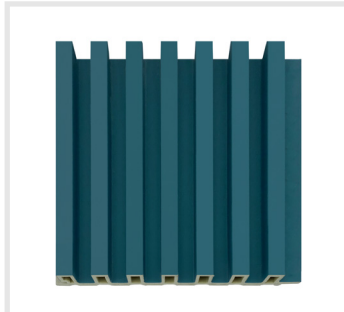

·M148 - QY-40 FG-006  
·M148 - 冰极绿



·M148 - QY-44 FG-010  
·M148 - 薄荷绿



·M148 - XR-20 BY-011  
·M148 - 莫兰迪 2



·M148 - XR-28 BY-019  
·M148 - 黑拉丝



·M148 - XR-57 MX-023  
·M148 - 科技柚木



·M148 - XR-58 MX-024  
·M148 - 科技木灰

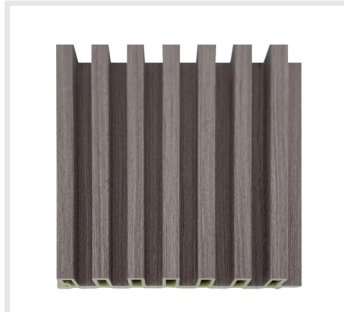

·M148 - XR-59 MX-025  
·M148 - 金丝檀木



·M148 - XR-60 MX-026  
·M148 - 米兰橡木



·M148 - XR-61 MX-027  
·M148 - 花火菲丝



·M148 - XR-63 MX-029  
·M148 - 酸枝木

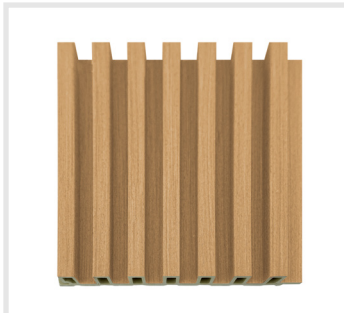

·M148 - XR-64 MX-030  
·M148 - 托尼木

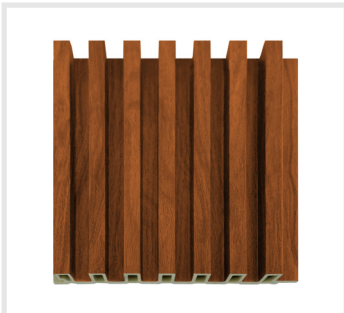

·M148 - XR-65 MX-031  
·M148 - 北美樱桃

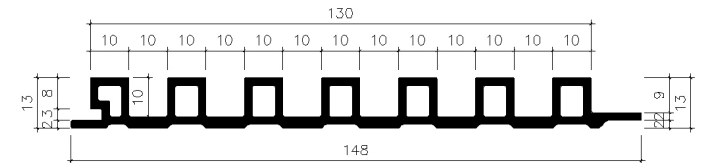

M148 细格栅

# Item:M159 Series



·M159 - XR-02 DC-002  
·M159 - 磨砂白



·M159 - XR-06 DL-002  
·M159 - 埃尔斯灰

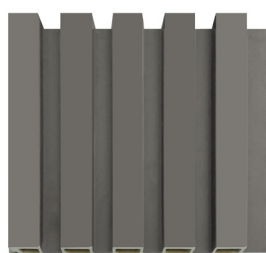

·M159 - QY-37 FG-003  
·M159 - 浅灰肤感

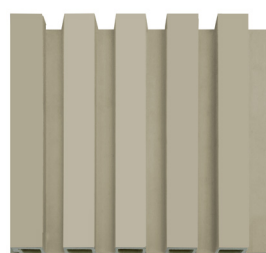

·M159 - QY-38 FG-004  
·M159 - 子午灰

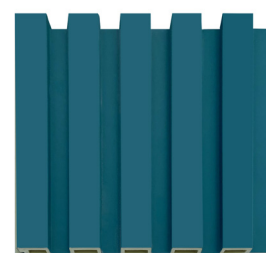

·M159 - QY-40 FG-006  
·M159 - 冰极绿

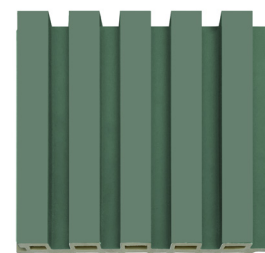

·M159 - QY-44 FG-010  
·M159 - 薄荷绿

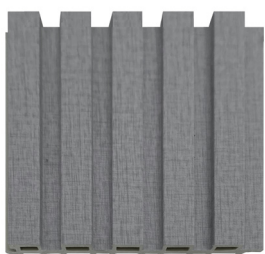

·M159 - XR-20 BY-011  
·M159 - 莫兰迪 2

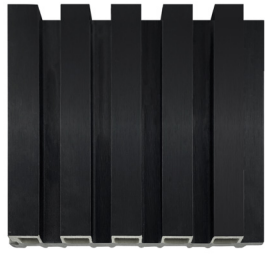

·M159 - XR-28 BY-019  
·M159 - 黑拉丝



·M159 - XR-57 MX-023  
·M159 - 科技柚木



·M159 - XR-58 MX-024  
·M159 - 科技木灰



·M159 - XR-59 MX-025  
·M159 - 金丝檀木



·M159 - XR-60 MX-026  
·M159 - 米兰橡木



·M159 - XR-61 MX-027  
·M159 - 花火菲丝



·M159 - XR-63 MX-029  
·M159 - 酸枝木

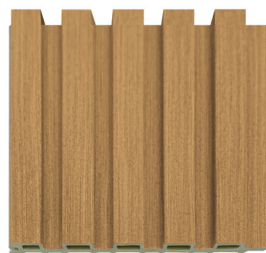

·M159 - XR-64 MX-030  
·M159 - 托尼木



·M159 - XR-65 MX-031  
·M159 - 北美樱桃

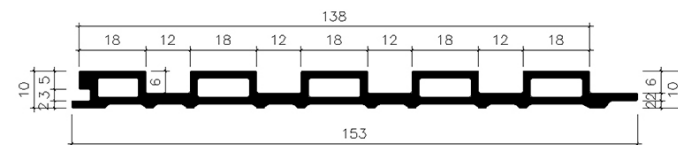

## M159 小长城

# Item:M170 Series

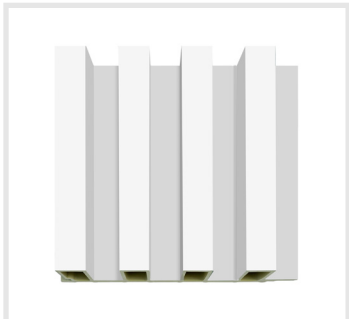

·M170 - XR-02 DC-002  
·M170 - 磨砂白



·M170 - XR-06 DL-002  
·M170 - 埃尔斯灰



·M170 - QY-37 FG-003  
·M170 - 浅灰肤感



·M170 - QY-38 FG-004  
·M170 - 子午灰

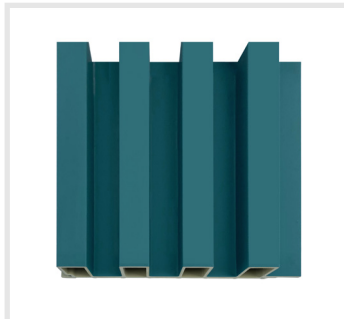

·M170 - QY-40 FG-006  
·M170 - 冰极绿



·M170 - QY-44 FG-010  
·M170 - 薄荷绿



·M170 - XR-20 BY-011  
·M170 - 莫兰迪 2



·M170 - XR-28 BY-019  
·M170 - 黑拉丝



·M170 - XR-57 MX-023  
·M170 - 科技柚木



·M170 - XR-58 MX-024  
·M170 - 科技木灰



·M170 - XR-59 MX-025  
·M170 - 金丝檀木



·M170 - XR-60 MX-026  
·M170 - 米兰橡木

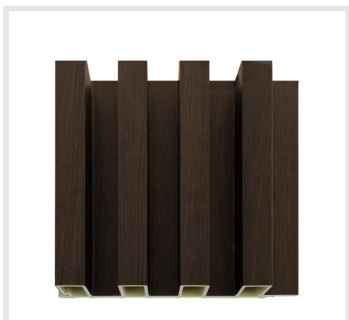

·M170 - XR-61 MX-027  
·M170 - 花火菲丝



·M170 - XR-63 MX-029  
·M170 - 酸枝木



·M170 - XR-64 MX-030  
·M170 - 托尼木

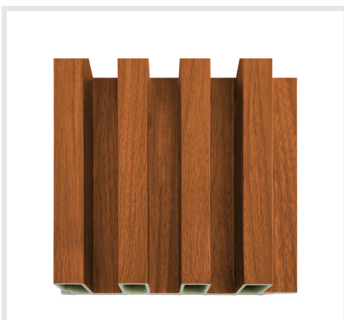

·M170 - XR-65 MX-031  
·M170 - 北美樱桃

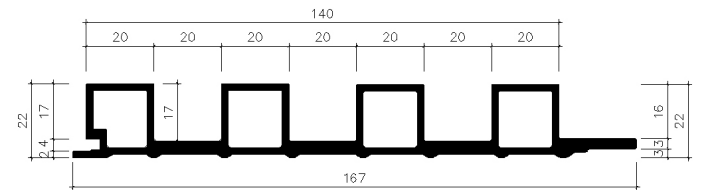

M170 格栅

# Item:M204 Series

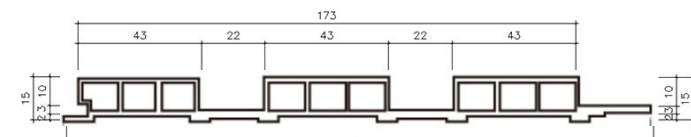
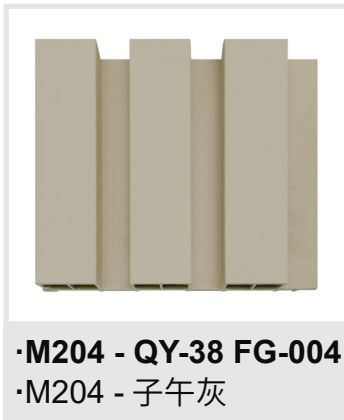

M204 长城板





# Item:S158 Series

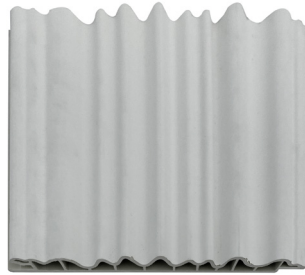

·S158 - QY35 FG-001  
·S158 - 伊丽莎白

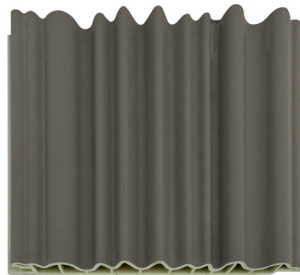

·S158 - QY-37 FG-003  
·S158 - 浅灰肤感

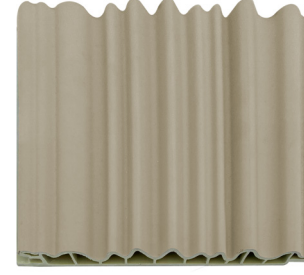

·S158 - QY-38 FG-004  
·S158 - 子午灰

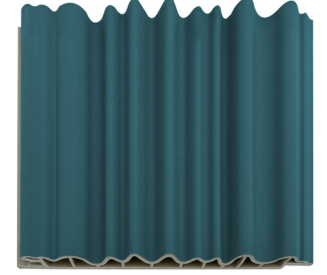

·S158 - QY-40 FG-006  
·S158 - 冰极绿

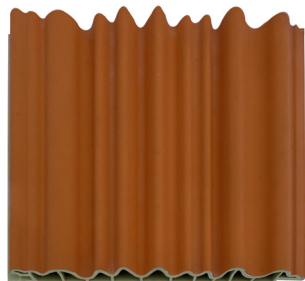

·S158 - QY-41 FG-007  
·S158 - 爱马仕橙



·S158 - QY-44 FG-010  
·S158 - 薄荷绿



S158 波浪板

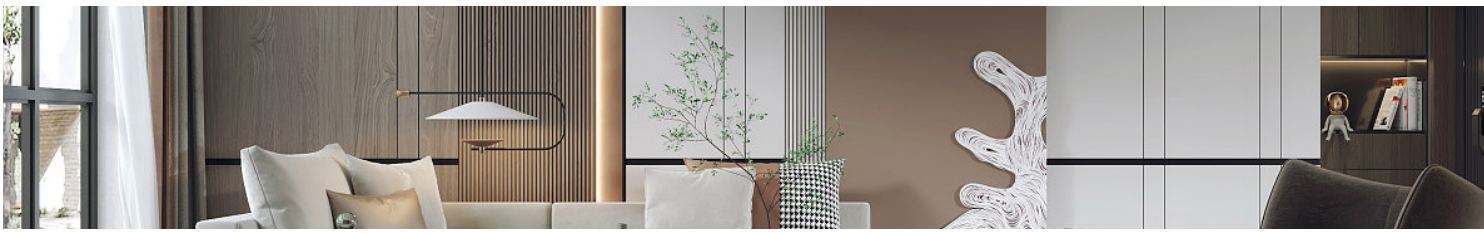

高端室内装饰板· 格栅系列  
High Quality Interior Wall Panel

## Item:M150Y Series



·M150Y - XR-02 DC-002  
·M150Y - 磨砂白



·M150Y - QY-38 FG-004  
·M150Y - 子午灰



·M150Y - QY-41 FG-007  
·M150Y - 爱马仕橙



·M150Y - XR-28 BY-019  
·M150Y - 黑拉丝

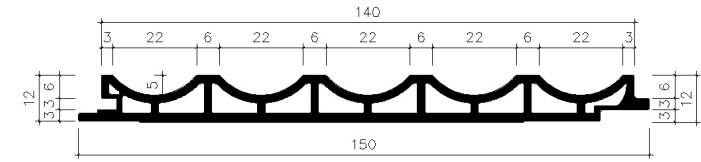

M150Y 内圆板

## Item:M150X Series



·M150X - QY-40 FG-006  
·M150X - 冰极绿



·M150X - QY-44 FG-010  
·M150X - 薄荷绿



·M150X - XR-28 BY-019  
·M150X - 黑拉丝



·M150X - XR-61 MX-027  
·M150X - 花火菲丝

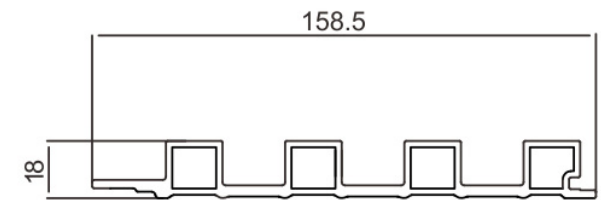

M150X 小格栅

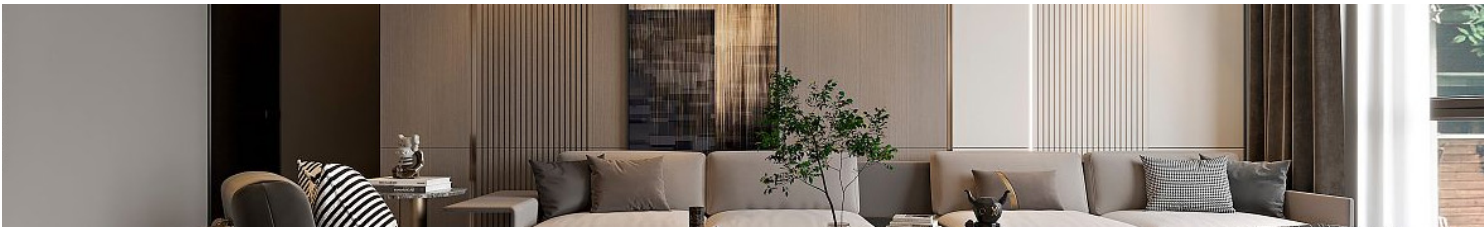

高端室内装饰板· 格栅系列

High Quality Interior Wall Panel

## Item:M158 Series



·M158 - QY-37 FG-003  
·M158 - 浅灰肤感



·M158 - QY-38 FG-004  
·M158 - 子午灰



·M158 - QY-40 FG-006  
·M158 - 冰地绿



·M158 - QY-44 FG-010  
·M158 - 薄荷绿

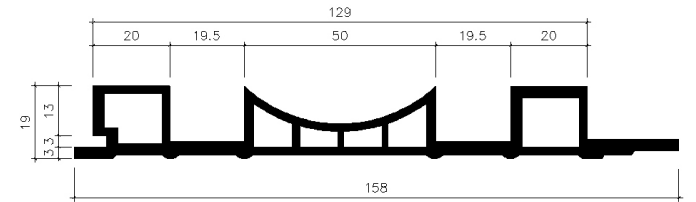

M158 中凹板

## Item:SM100 Series



·SM100 - XR-02 DC-002  
·SM100 - 磨砂白

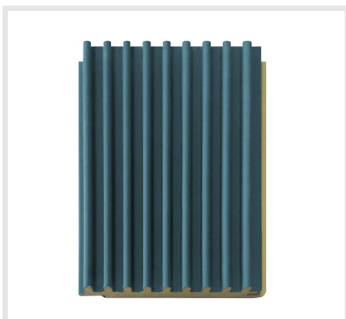

·SM100 - QY-40 FG-006  
·SM100 - 冰极绿

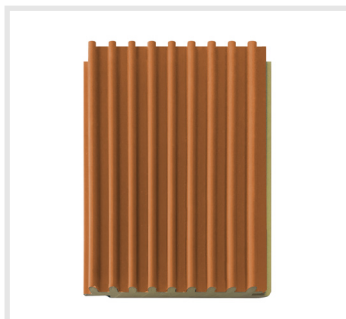

·SM100 - QY-41 FG-007  
·SM100 - 爱马仕橙



·SM100 - QY-44 FG-010  
·SM100 - 薄荷绿

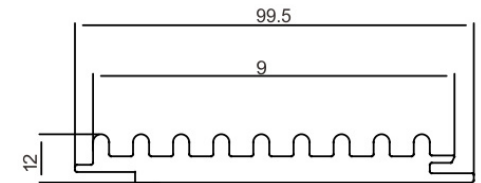

SM100 波浪板



高端室内装饰板· 格栅系列  
High Quality Interior Wall Panel

## Item:S128 Series



·S128 - QY-40 FG-006  
·S128 - 冰极绿



·S128 - QY-44 FG-010  
·S128 - 薄荷绿



·S128 - XR-57 MX-023  
·S128 - 科技柚木



·S128 -XR-61 MX-027  
·S128 - 花火菲丝

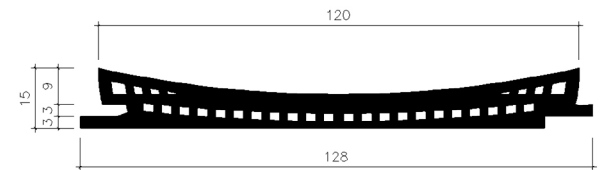

S128 半月板

## Item:M160 Series



·M160 - XR-57 MX-023  
·M160 - 科技柚木



·M160 - XR-58 MX-024  
·M160 - 科技木灰



·M160 -XR-61 MX-027  
·M160 - 花火菲丝



·M160 - XR-63 MX-029  
·M160 - 酸枝木

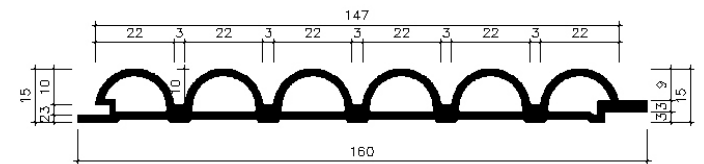

M160 小圆板



高端室内装饰板· 格栅系列

High Quality Interior Wall Panel

## Item:M178 Series



·M178 - QY-37 FG-003  
·M178 - 浅灰肤感



·M178 - QY-40 FG-006  
·M178 - 冰极绿



·M178 - QY-44 FG-010  
·M178 - 薄荷绿



·M178 - XR-28 BY-019  
·M178 - 黑拉丝

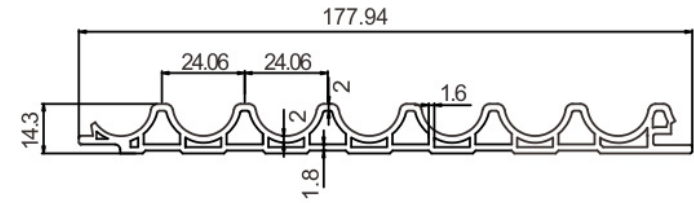

M178 内圆板

## Item:M180 Series



·M180 - QY-40 FG-006  
·M180 - 冰极绿



·M180 - QY-44 FG-010  
·M180 - 薄荷绿



·M180 - XR-28 BY-019  
·M180 - 黑拉丝



·M180 - XR-64 MX-030  
·M180 - 托尼木

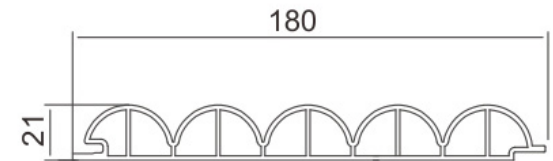

M180 外弧装饰板



高端室内装饰板· 格栅系列

High Quality Interior Wall Panel

## Item:M196 Series

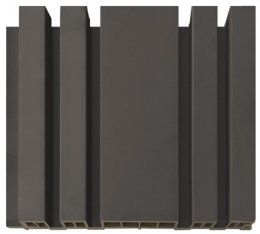

·M196 - QY-37 FG-003  
·M196 - 浅灰肤感



·M196 - QY-38 FG-004  
·M196 - 子午灰



·M196 - QY-40 FG-006  
·M196 - 冰极绿



·M196 - QY-44 FG-010  
·M196 - 薄荷绿

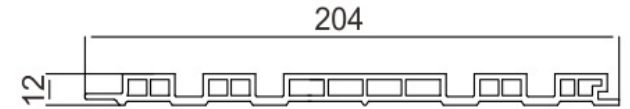

M196 组合板

## Item:M205 Series



·M205 - QY-35 FG-001  
·M205 - 伊丽莎白



·M205 - XR-57 MX-023  
·M205 - 科技柚木



·M205 - XR-60 MX-026  
·M205 - 米兰橡木



·M205 - XR-65 MX-031  
·M205 - 北美樱桃

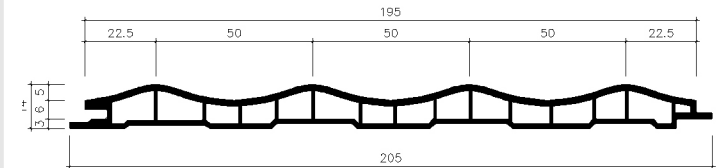

M205 外圆板

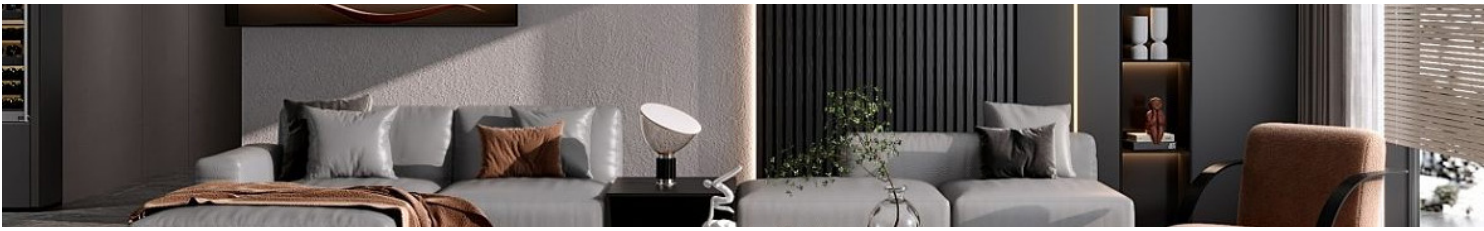

高端室内装饰板· 格栅系列  
High Quality Interior Wall Panel

## Item:S207 Series



·S207 - XR-60 MX-026  
·S207 - 米兰橡木



·S207 - XR-58 MX-024  
·S207 - 科技木灰



·S207 - XR-63 MX-029  
·S207 - 酸枝木



·S207 -XR-61 MX-027  
·S207 - 花火菲丝

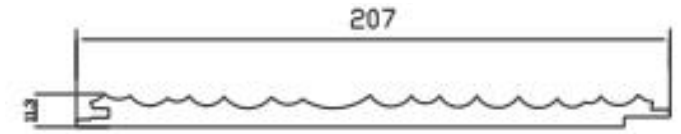

S207 波浪板

## Item:M210 Series



·M210 - QY-40 FG-006  
·M210 - 冰极绿



·M210 - QY-41 FG-007  
·M210 - 爱马仕橙



·M210 - QY-44 FG-010  
·M210 - 薄荷绿



·M210 - XR-28 BY-019  
·M210 - 黑拉丝

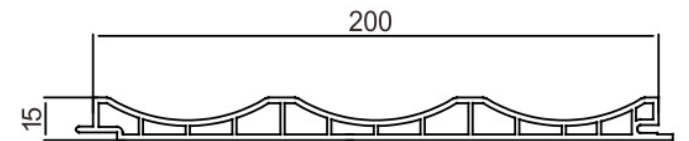

M210 三圆板



高端室内装饰板· 格栅系列  
High Quality Interior Wall Panel

## Item:M240 Series



·M240 - XR-28 BY-019  
·M240 - 黑拉丝



·M240 -XR-61 MX-027  
·M240 - 花火菲丝



·M240 - XR-63 MX-029  
·M240 - 酸枝木



·M240 - XR-65 MX-031  
·M240 - 北美樱桃

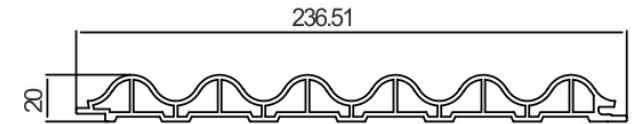

M240 圆弧板

## Item:M300A Series



·M300A - XR-57 MX-023  
·M300A - 科技柚木



·M300A - XR-58 MX-024  
·M300A - 科技木灰



·M300A - XR-60 MX-026  
·M300A - 米兰橡木



·M300A -XR-61 MX-027  
·M300A - 花火菲丝

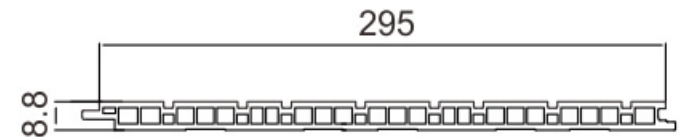

M300A 中凹板





高端室内装饰板· 格栅系列  
High Quality Interior Wall Panel

## Item:MT110 Series



·MT110 - QY-37 FG-003  
·MT110 - 浅灰肤感



·MT110 - QY-38 FG-004  
·MT110 - 子午灰



·MT110 - QY-40 FG-006  
·MT110 - 冰极绿



·MT110 - QY-44 FG-010  
·MT110 - 薄荷绿

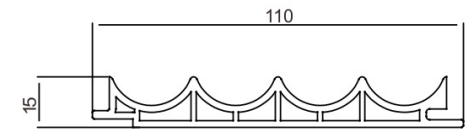

MT110 内圆板

## Item:S125 Series



·S125 - QY-40 FG-006  
·S125 - 科技柚木



·S125 - QY-44 FG-010  
·S125 - 米兰橡木



·S125 - XR-28 BY-019  
·S125 - 酸枝木



·S125 -XR-64 MX-030  
·S125 - 托尼木

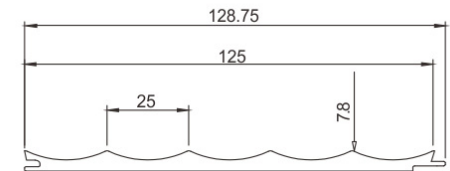

S125 波浪板



高端室内装饰板· 格栅系列  
High Quality Interior Wall Panel

## Item:S159 Series

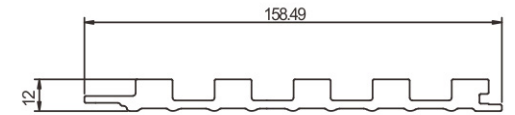
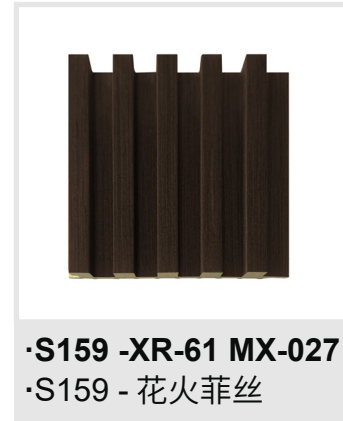
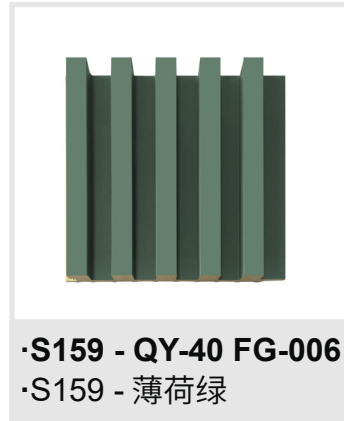
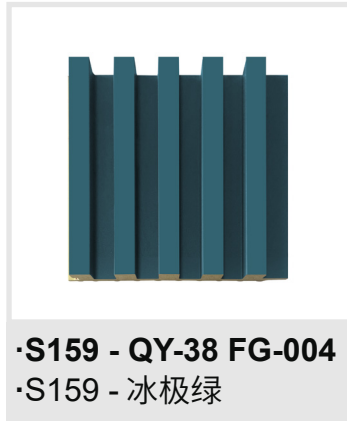

S159 实心格栅

## Item:S1516 Series

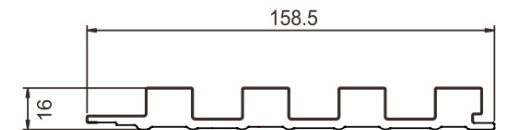
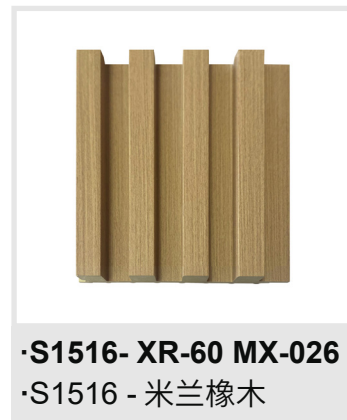

S1516 实心格栅



高端室内装饰板· 格栅系列  
High Quality Interior Wall Panel

## Item:S162 Series

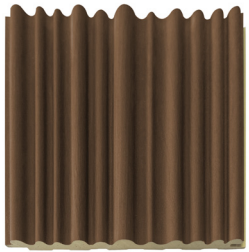

·S162 - QY-40 FG-006  
·S162 - 科技柚木

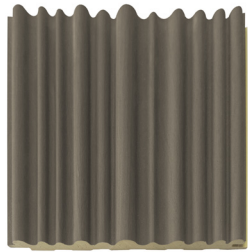

·S162 - QY-44 FG-010  
·S162 - 科技木灰

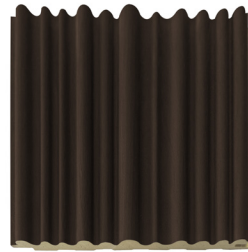

·S162 - XR-28 BY-019  
·S162 - 花火菲丝

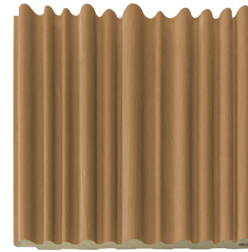

·S162 -XR-64 MX-030  
·S162 - 托尼木

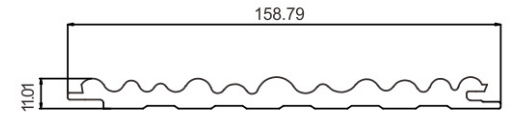

S162 波浪板

## Item:S7015 Series



·S7015 - XR-57 MX-023  
·S7015 - 浅灰肤感



·S7015 -XR-61 MX-027  
·S7015 - 花火菲丝



·S7015 - XR-63 MX-029  
·S7015 - 酸枝木



·S7015 - XR-65 MX-031  
·S7015 - 北美樱桃

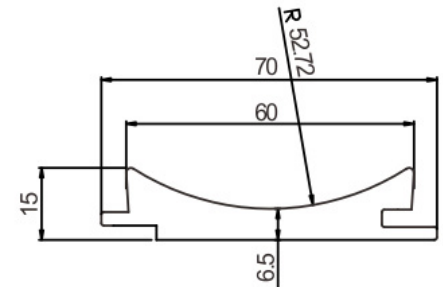

S7015 半月板

# Wall Panel



高端室内装饰板· 现货供应

High Quality Interior Wall Panel

# Item:M300B Series



·M300B - QY-35 FG-001  
·M300B - 伊丽莎白



·M300B - QY-36 FG-002  
·M300B - 黄卡其



·M300B - QY-37 FG-003  
·M300B - 浅灰肤感



·M300B - QY-38 FG-004  
·M300B - 子午灰



·M300B - QY-40 FG-006  
·M300B - 冰极绿



·M300B - QY-41 FG-007  
·M300B - 爱马仕橙



·M300B - XR-28 BY-019  
·M300B - 黑拉丝

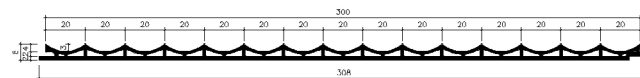

M300B 波浪板



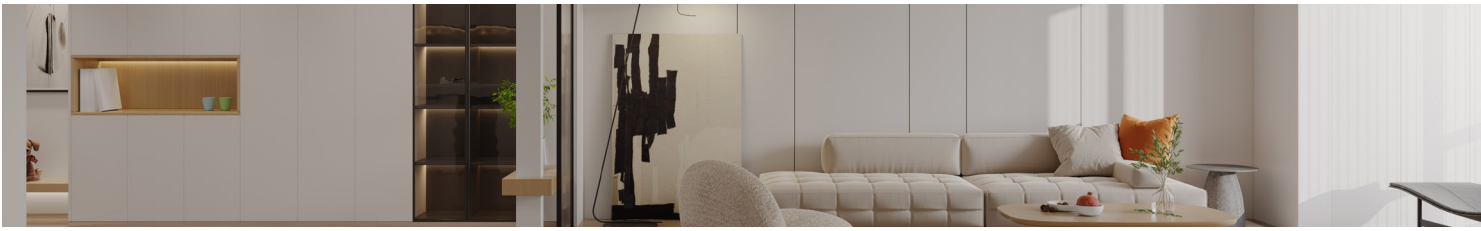

高端室内装饰板·装饰板系列  
High Quality Interior Wall Panel

## Item:120 Series



·120 - QY-38 FG-004  
·120 - 子午灰



·120 - QY-40 FG-006  
·120 - 冰极绿



·120 - QY-44 FG-010  
·120 - 薄荷绿



·120 - XR-28 BY-019  
·120 - 黑拉丝

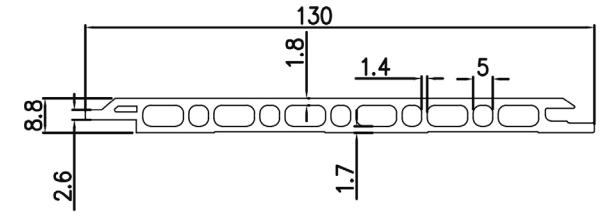

120 装饰板

## Item:M195 Series



·M195 - XR-57 MX-023  
·M195 - 科技柚木



·M195- XR-60 MX-026  
·M195 - 米兰橡木



·M195 -XR-61 MX-027  
·M195 - 花火菲丝

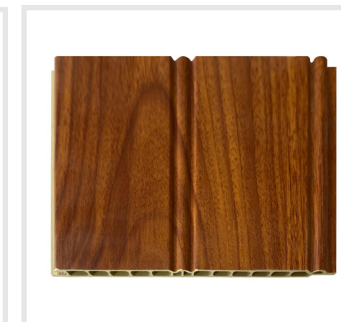

·M195 - XR-63 MX-029  
·M195 - 酸枝木

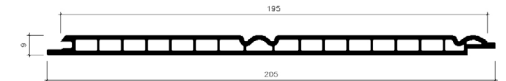

M195 中板



高端室内装饰板·配件系列  
High Quality Interior Wall Panel

## Item:SH52P Series



·SH52P - QY-37 FG-003  
·SH52P - 浅灰肤感



·SH52P - QY-41 FG-007  
·SH52P - 爱马仕橙



·SH52P - QY-44 FG-010  
·SH52P - 薄荷绿



·SH52P - XR-28 BY-019  
·SH52P - 黑拉丝

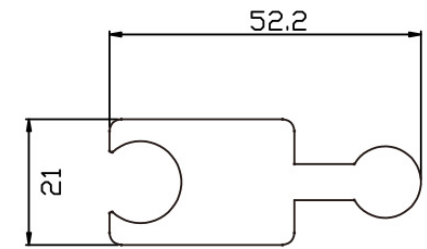

SH52P 平弧

## Item:SH52Y Series



·SH52Y - QY-37 FG-003  
·SH52Y - 浅灰肤感



·SH52Y - QY-40 FG-006  
·SH52Y - 冰极绿



·SH52Y - QY-41 FG-007  
·SH52Y - 爱马仕橙



·SH52Y - QY-44 FG-010  
·SH52Y - 薄荷绿

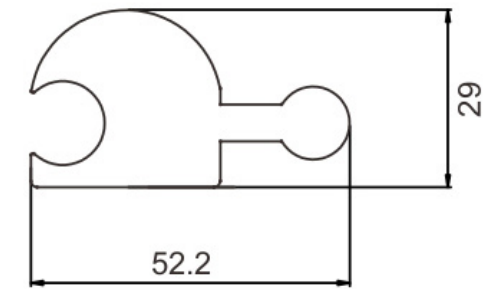

SH52Y 圆弧





高端室内装饰板·配件系列  
High Quality Interior Wall Panel

## Item:SH55 Series



·SH55 - QY-40 FG-006  
·SH55 - 冰极绿



·SH55 - QY-41 FG-007  
·SH55 - 爱马仕橙



·SH55 - QY-44 FG-010  
·SH55 - 薄荷绿



·SH55 -XR-61 MX-027  
·SH55 - 花火菲丝

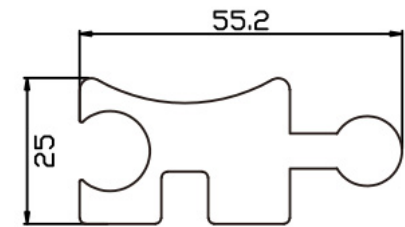

SH55 半弧

## Item:L25 Series



·L25 - QY-37 FG-003  
·L25 - 浅灰肤感



·L25 - QY-40 FG-006  
·L25 - 冰极绿



·L25 - QY-44 FG-010  
·L25 - 薄荷绿

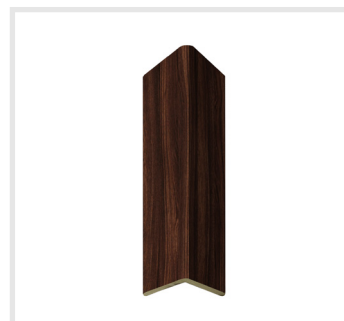

·L25 - XR-61 MX-027  
·L25 - 花火菲丝

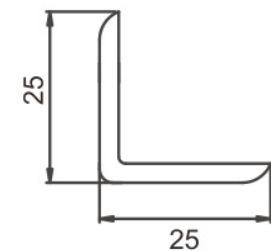

L25 阳角线



高端室内装饰板·配件系列  
High Quality Interior Wall Panel

## Item:S50 Series



·S50 - QY-37 FG-003  
·S50 - 浅灰肤感



·S50 - QY-40 FG-006  
·S50 - 冰极绿



·S50 - QY-44 FG-010  
·S50 - 薄荷绿



·S50 -XR-61 MX-027  
·S50 - 花火菲丝

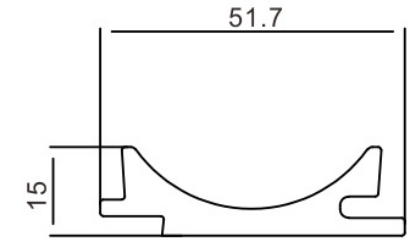

S50 半月板

## Item:MD100 Series



·MD100 - QY-40 FG-006  
·MD100 - 冰极绿

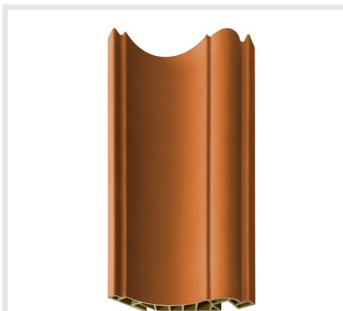

·MD100 - QY-41 FG-007  
·MD100 - 爱马仕橙



·MD100 - QY-44 FG-010  
·MD100 - 薄荷绿



·MD100 - XR-28 BY-019  
·MD100 - 黑拉丝

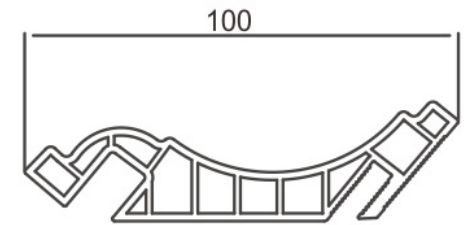

MD100 顶线



高端室内装饰板· 配件系列  
High Quality Interior Wall Panel

## Item:MT100 Series



·MT100- XR-02 DC-002  
·MT100 - 磨砂白



·MT100 - QY-40 FG-006  
·MT100 - 冰极绿



·MT100 - QY-44 FG-010  
·MT100 - 薄荷绿



·MT100 - XR-28 BY-019  
·MT100 - 黑拉丝

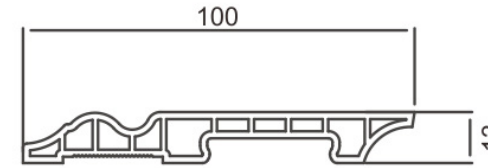

MT100 踢脚线

## Item:P60 Series



·P60- QY-37 FG-003  
·P60 - 浅灰肤感



·P60 - QY-40 FG-006  
·P60 - 冰极绿



·P60 - QY-44 FG-010  
·P60 - 薄荷绿



·P60 - XR-28 BY-019  
·P60 - 黑拉丝

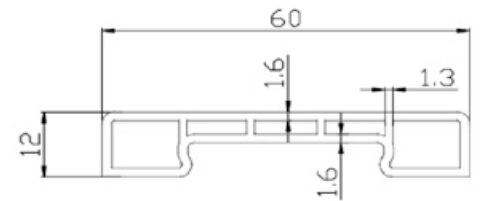

P60 (平线)



高端室内装饰板·配件系列

High Quality Interior Wall Panel

## Item:Y35 Series



·Y35 - QY-40 FG-006  
·Y35 - 冰极绿



·Y35 - QY-44 FG-010  
·Y35 - 薄荷绿



·Y35 - XR-57 MX-023  
·Y35 - 科技柚木



·Y35 -XR-61 MX-027  
·Y35 - 花火菲丝

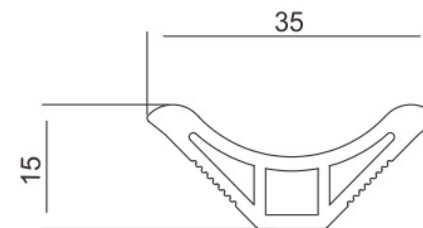

Y35 阴角线

## Item:Z55 Series



·Z55 - QY-38 FG-004  
·Z55 - 子午灰



·Z55 - QY-40 FG-006  
·Z55 - 冰极绿



·Z55 - QY-44 FG-010  
·Z55 - 薄荷绿



·Z55 - XR-28 BY-019  
·Z55 - 黑拉丝

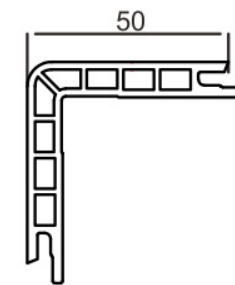

Z55 转角 (直缝 / V 缝)

